

**HART® Operation Manual**

X-DPT-HART-QmB-eng

Part Number: 541B043AAG

June, 2017

# QUANTIM® Precision Mass Flow Meters/Controllers HART® Communication Operation and Set-Up Manual

## Essential Instructions Read before proceeding!

Brooks Instrument designs, manufactures and tests its products to meet many national and international standards. These products must be properly installed, operated and maintained to ensure they continue to operate within their normal specifications. The following instructions must be adhered to and integrated into your safety program when installing, operating and maintaining Brooks Instrument products.

- To ensure proper performance, use qualified personnel to install, operate, update, program and maintain the product.
- Read all instructions prior to installing, operating and servicing the product. If this instruction manual is not the correct manual, please see back cover for local sales office contact information. Save this instruction manual for future reference.

**▲ WARNING: Do not operate this instrument in excess of the specifications listed in the Instruction and Operation Manual. Failure to heed this warning can result in serious personal injury and / or damage to the equipment.**

- If you do not understand any of the instructions, contact your Brooks Instrument representative for clarification.
- Follow all warnings, cautions and instructions marked on and supplied with the product.

**▲ WARNING: Prior to installation ensure this instrument has the required approval ratings to meet local and national codes. Failure to heed this warning can result in serious personal injury and / or damage to the equipment.**

- Install your equipment as specified in the installation instructions of the appropriate instruction manual and per applicable local and national codes. Connect all products to the proper electrical and pressure sources.
- Operation: (1) Slowly initiate flow into the system. Open process valves slowly to avoid flow surges. (2) Check for leaks around the flow meter inlet and outlet connections. If no leaks are present, bring the system up to the operating pressure.
- Please make sure that the process line pressure is removed prior to service. When replacement parts are required, ensure that qualified people use replacement parts specified by Brooks Instrument. Unauthorized parts and procedures can affect the product's performance and place the safe operation of your process at risk. Look-alike substitutions may result in fire, electrical hazards or improper operation.
- Ensure that all equipment doors are closed and protective covers are in place to prevent electrical shock and personal injury, except when maintenance is being performed by qualified persons.

**▲ WARNING: For liquid flow devices, if the inlet and outlet valves adjacent to the devices are to be closed for any reason, the devices must be completely drained. Failure to do so may result in thermal expansion of the liquid that can rupture the device and may cause personal injury.**

### European Pressure Equipment Directive (PED)

All pressure equipment with an internal pressure greater than 0.5 bar (g) and a size larger than 25mm or 1" (inch) falls under the Pressure Equipment Directive (PED).

- The Specifications Section of this manual contains instructions related to the PED directive.
- Products described in this manual are in compliance with EN directive 2014/34/EU.
- All Brooks Instrument Flowmeters fall under fluid group 1.
- Products larger than 25mm or 1" (inch) are in compliance with PED category I, II or III.
- Products of 25mm or 1" (inch) or smaller are Sound Engineering Practice (SEP).

### European Electromagnetic Compatibility (EMC)

The Brooks Instrument (electric/electronic) equipment bearing the CE mark has been successfully tested to the regulations of the Electro Magnetic Compatibility (EMC directive 2014/30/EU).

Special attention however is required when selecting the signal cable to be used with CE marked equipment.

**Quality of the signal cable, cable glands and connectors:**

Brooks Instrument supplies high quality cable(s) which meets the specifications for CE certification.

If you provide your own signal cable you should use a cable which is overall completely screened with a 100% shield.

"D" or "Circular" type connectors used should be shielded with a metal shield. If applicable, metal cable glands must be used providing cable screen clamping.

The cable screen should be connected to the metal shell or gland and shielded at both ends over 360 Degrees.

The shield should be terminated to an earth ground.

Card Edge Connectors are standard non-metallic. The cables used must be screened with 100% shield to comply with CE certification.

The shield should be terminated to an earth ground.

For pin configuration : Please refer to the enclosed Instruction Manual.

### ESD (Electrostatic Discharge)

**▲ CAUTION: This instrument contains electronic components that are susceptible to damage by static electricity. Proper handling procedures must be observed during the removal, installation or other handling of internal circuit boards or devices.**

**Handling Procedure:**

1. Power to unit must be removed.
2. Personnel must be grounded, via a wrist strap or other safe, suitable means before any printed circuit card or other internal device is installed, removed or adjusted.
3. Printed circuit cards must be transported in a conductive container. Boards must not be removed from protective enclosure until immediately before installation. Removed boards must immediately be placed in protective container for transport, storage or return to factory.

**Comments**

This instrument is not unique in its content of ESD (electrostatic discharge) sensitive components. Most modern electronic designs contain components that utilize metal oxide technology (NMOS, SMOS, etc.). Experience has proven that even small amounts of static electricity can damage or destroy these devices. Damaged components, even though they appear to function properly, exhibit early failure.

**Section 1 Introduction**

<u>Section Number</u>	<u>Page Number</u>
1-1 Description .....	1-1

**Section 2 Operation and Setup**

<u>Section Number</u>	<u>Page Number</u>
2-1 Connecting a HART® Communicator .....	2-1
2-2 Establishing Communications .....	2-3
2-3 Device Setup .....	2-3
2-4 Diagnostics and Service .....	2-4
2-5 Basic setup .....	2-5
2-6 Primary and Secondary A/O Menus .....	2-5
2-7 A/I Setup .....	2-8
2-8 Detailed Setup .....	2-8
2-9 Analog I/O Configuration .....	2-9
2-10 Alarms .....	2-14
2-11 Configuring Alarms .....	2-15
2-12 Device Information .....	2-16
2-13 Hot Keys .....	2-18

<b>Warranty, Local Sales/Service Contact Information .....</b>	<b>Back Cover</b>
--	-------------------

**Figures**

<u>Figure Number</u>	<u>Page Number</u>
2-1 Proper Wiring of a Brooks QUANTIM™ NEMA1/ IP40 .....	2-1
2-2 Proper Wiring of a Brooks QUANTIM™ NEMA 4X/ IP66 .....	2-2
2-3 Proper Wiring of a Brooks QUANTIM™ NEMA 4X/ IP66XP .....	2-2
2-4 Home Menu Tree .....	2-20

**Tables**

<u>Table Number</u>	<u>Page Number</u>
1-1 Variable Assignments .....	1-2
2-1 Supported HART® Protocol Commands .....	2-18

*THIS PAGE WAS  
INTENTIONALLY  
LEFT BLANK*

**1-1 Introduction**

---

This manual provides information about the Brooks® QUANTIM's support of the HART® Communications protocol and only applies to devices equipped with 4-20 mA analog I/O with HART. For complete installation and operation instructions for your QUANTIM Precision Mass Flow Product please see the Installation and Operation Manual provided with your device.

The HART Communication Protocol describes a network of devices that consists of one "Master" device and one or more Slave device(s) which are connected by and communicate using FSK Physical Layer Interface. FSK Physical Layer Interface uses 1200 baud binary phase-continuous Frequency-shift Keying (FSK) resulting in a high frequency current superimposed on the 4-20 mA current output of the device. Brooks' QUANTIM supports HART Revision 5 communications protocol with the FSK Physical Layer Interface and is implemented as a "Slave" device on HART network. QUANTIM cannot be implemented as a "Master" device or support Burst Mode as a "Slave" device.

Any master with a HART compatible modem can communicate with a Brooks QUANTIM Mass Flow Device by using the HART Communications protocol as defined by the HART Communication Foundation. For more information on the HART Communications protocol, visit the HART Communication Foundation website at [www.FieldCommGroup.org](http://www.FieldCommGroup.org)

Brooks' QUANTIM fully supports the HART Universal Command Set and provides additional functionality via many HART Common Practice commands and product specific commands. Table 2-1 contains a summary of the commands supported by Brooks' QUANTIM. For detailed documentation on the commands supported by Brooks' QUANTIM, contact the factory.

The most common master used for communications is an Emerson HART Handheld Communicator, commonly referred to as the HART Communicator. When connected to a Brooks QUANTIM, the HART Communicator allows the user to view process information and to modify configuration parameters via a series of menus and displays that are customized for Brooks QUANTIM. Functionality available when using a HART Communicator includes:

- Viewing process parameters
  - Mass Flow
  - Density
  - Volumetric Flow
  - Temperature
  - Setpoint
- Re-ranging the Analog Inputs and Outputs
- Trimming the Analog Inputs and Outputs
- Zeroing the Flow Sensor
- Output Damping
- Remote Valve Override
- Configuring and Monitoring Alarms
- View device specific information
  - Tag Name
  - Model Number
  - Serial Number

### **HART Nomenclature**

Before proceeding, it is important to understand some important HART “jargon” and how it relates to a Brooks QUANTIM. The Underlined words in the following paragraphs are frequently used HART “jargon”.

A **Process Variable** is the process data measured or computed within a device. Brooks QUANTIM has 5 Process Variables: Mass Flow, Density, Volumetric Flow, Temperature, and Setpoint. Each Process Variable has the following common attributes: Value and Unit of Measure. The Units of Measure for each Process Variable is configurable by the user but limited to Units which are meaningful to the Process Variable.

The Process Variables are assigned to four Dynamic Variables: **Primary Variable (PV)**, **Secondary Variable (SV)**, **Tertiary Variable (TV)**, and **4<sup>th</sup> Variable (QV)**. The assignment of Process Variables to Dynamic Variables serves two purposes. First, many commands in the Hart Universal Command Set and many in the Common Practice command set access transmitter information via the Dynamic Variables. This allows some HART masters to access Process Variables generically, without any "inner working" knowledge of the device. Second, the Analog Outputs of a device are associated with the Process Variables via their Dynamic Variable assignments. The Brooks QUANTIM Dynamic Variable assignments are shown in Table 1-1. These assignments are not user configurable.

*Table 1-1 Variable Assignments*

Process Variable	Dynamic Variable
Mass Flow	PV
Density	SV
Volumetric Flow	TV
Temperature	QV

The Brooks QUANTIM has 2 analog outputs that are designated the **Primary Output** and the **Secondary Output**. The Primary Output will always represent the value of the Primary Variable (PV) and the Secondary Output will always represent the value of the Secondary Variable (SV).

PV and SV each have two attributes for setting the range of the associated analog output. These attributes are **Upper Range Value (URV)** and **Lower Range Value (LRV)**. The Upper Range Value attribute defines the value of the PV or SV which will be represented by the analog output as the full-scale value, normally 20 mA. Likewise, the Lower Range Value attribute defines the value of the PV or SV which will be represented by the analog output as the minimum-scale value, normally 4 mA.

#### **Example**

A Brooks QUANTIM is configured with:

Upper Range Value is 1000 grams/hr

Lower Range Value is 0 grams/hr

PV is Mass Flow with a current flowrate of 500 grams/hr which is 50% of the range specified by the Upper Range Value and the Lower Range Value. Therefore, the analog output will be set to 50% of its range which, for a 4-20 mA output would be 12 mA.

The Setpoint Process Variable is an unusual variable in that it is associated with an Analog Input instead of an Analog Output. It has Value, Units of Measure, Upper Range Value, and Lower Range Value attributes, just as the Primary Variable and the Secondary Variable have.

*THIS PAGE WAS  
INTENTIONALLY  
LEFT BLANK*



**2-1 Connecting a HART® Communicator**

Refer to Figure 2-1 for proper wiring of a Brooks QUANTIM™. It is important to note that unlike most HART® compatible transmitters, the Brooks QUANTIM is not a loop powered device. It requires separate power inputs. Thus, the Brooks QUANTIM is able to source current for the Primary and Secondary Analog Outputs.

HART Communications is provided on the Primary Output of the Brooks QUANTIM device. Connecting a HART Communicator, or any HART Modem, requires a connection between pins 4 and 10 as shown in Figure 2-1. This connection can be anywhere on the current loop as shown in the diagram.

Push the ON button (labeled I/O) on the HART Communicator to begin communications.

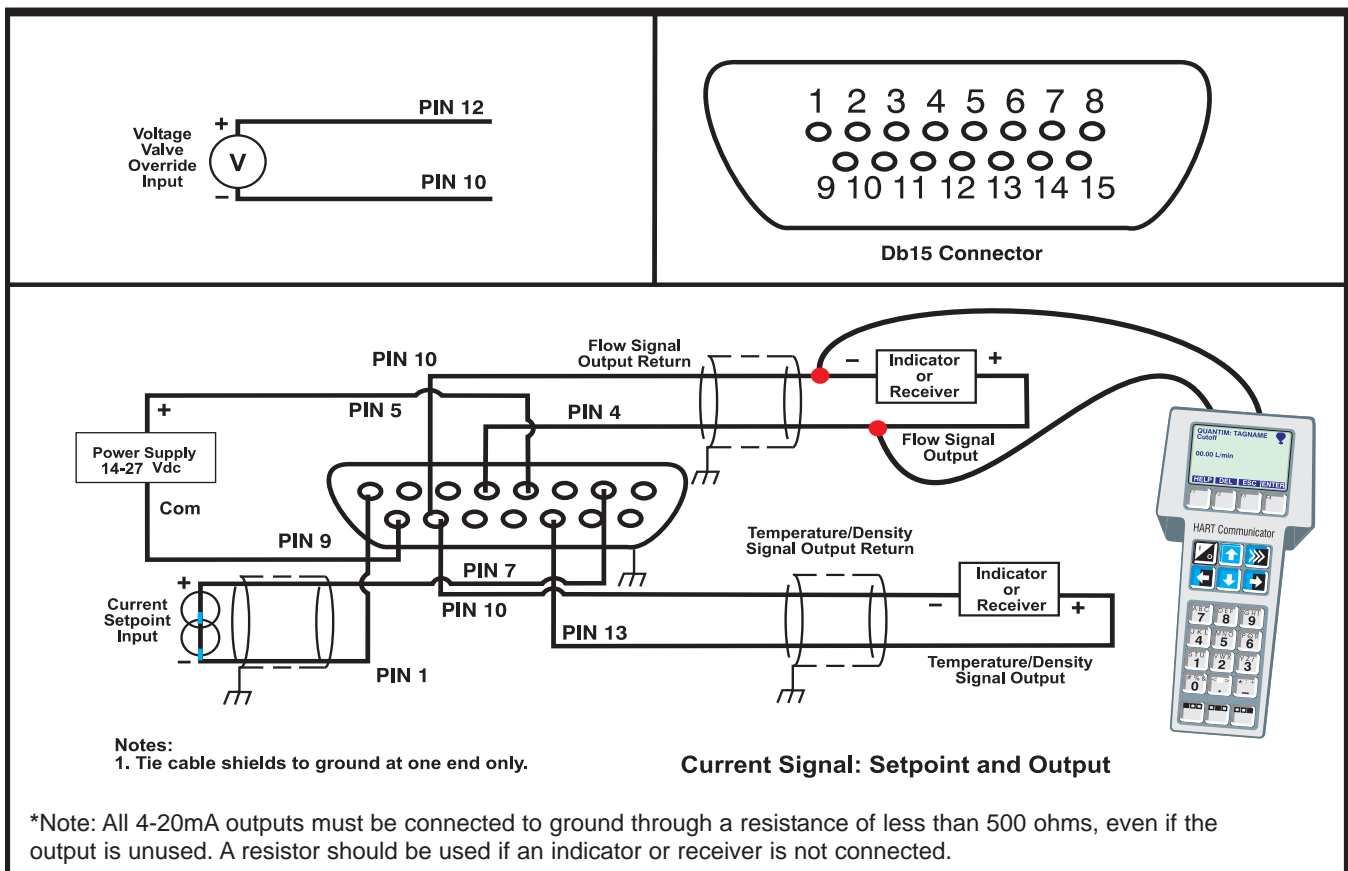

Figure 2-1 Proper Wiring of a Brooks QUANTIM NEMA 1/ IP40

HART® Operation Manual - QUANTIM®

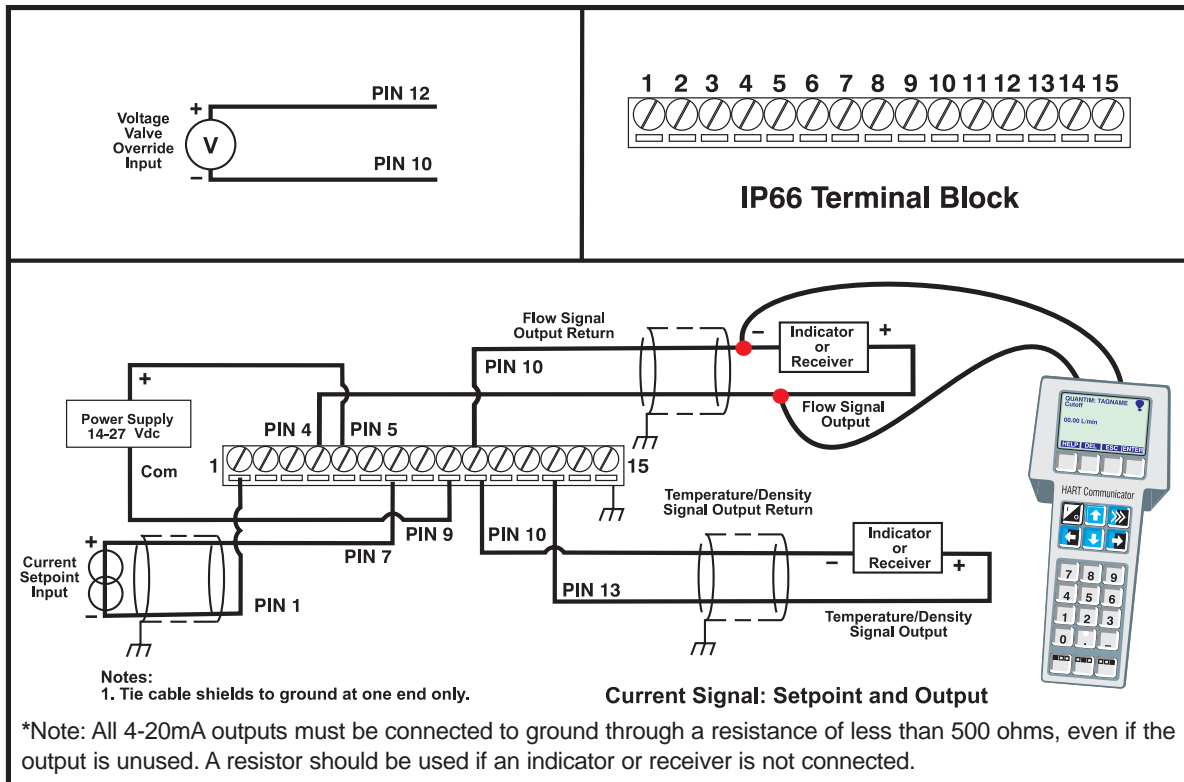

Figure 2-2 Proper Wiring of a Brooks QUANTIM NEMA 4X/ IP66

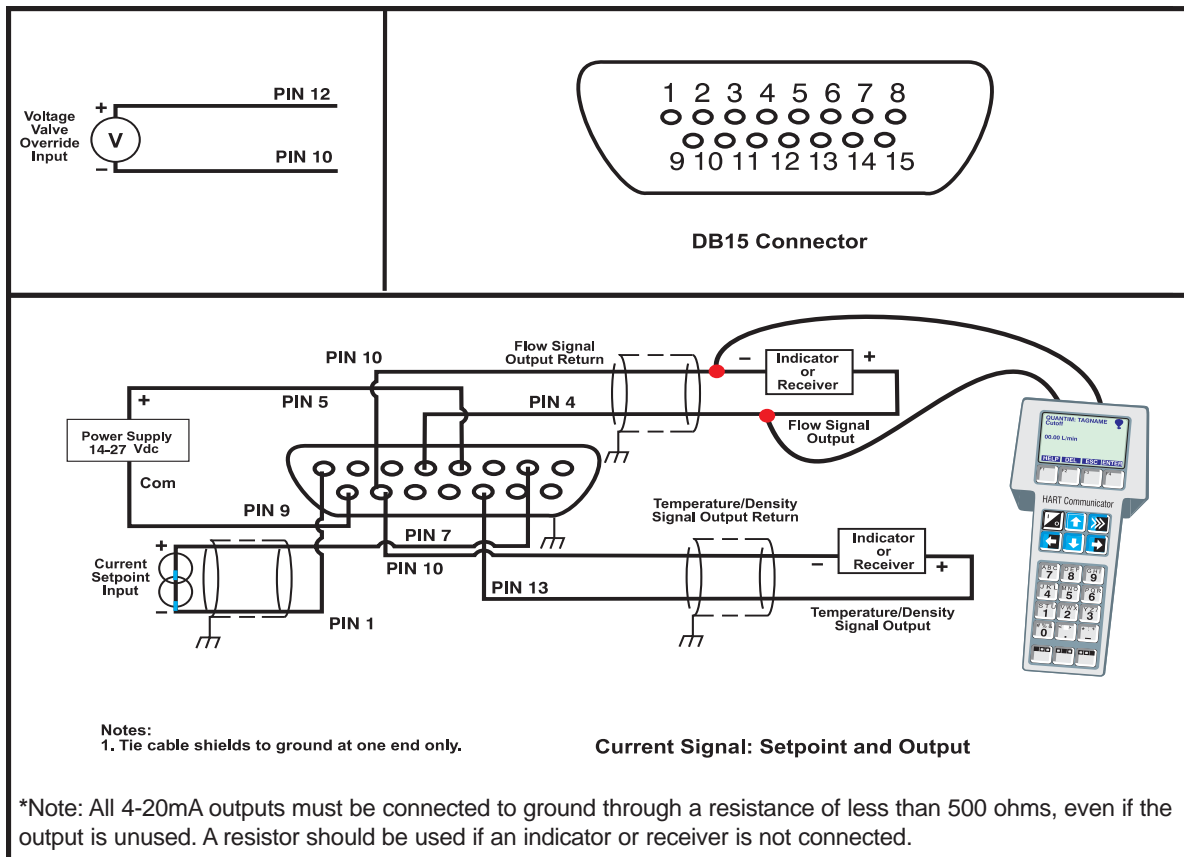

Figure 2-3 Proper Wiring of a Brooks QUANTIM NEMA 4X/ IP66XP

**2-2 Establishing Communications**

Once the ON button is pressed, the HART Communicator will attempt to establish communications with the Brooks QUANTIM. If successful, the QUANTIM Home Menu will be displayed as shown below. The Home Menu actively displays the device type, QUANTIM, followed by the device tagname, the current values of the Primary Variable and the Setpoint Variable as well as their respective analog output and input values. These values are updated continuously.

Selecting “Device Setup” allows the user to enter the custom QUANTIM menu tree which allows the user to view and/or modify other device parameters.

(A chart of the QUANTIM menu tree is provided in Figure 2-4).

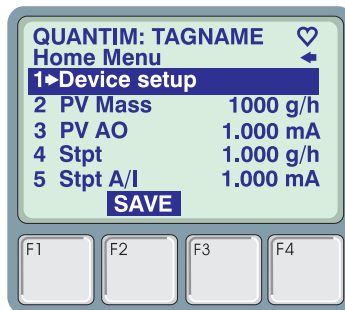

If “GENERIC” appears on the Top line of the display, then the Memory Module of the HART Communicator does not have the information required to display the QUANTIM custom menu tree. Some limited functionality is still available in the Generic Menu tree, however, to gain access to the custom QUANTIM menu tree, contact your nearest Fisher-Rosemount Service Representative to have your memory module upgraded.

If the HART Communicator cannot establish communications with the Brooks QUANTIM, then “No Device Found” will be displayed for a short period, followed by the Offline menu. For details on using the Offline Menu, refer to the [Hart Communicator Users Manual](#).

**2-3 Device Setup**

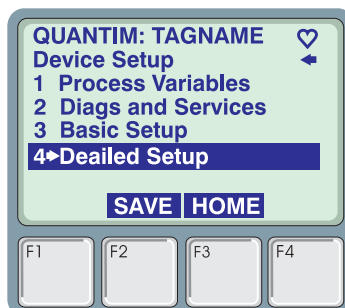

## HART® Operation Manual - QUANTIM®

The Device Setup menu is the gateway to the Brooks QUANTIM menu tree. Select one of the four menu choices to continue.

1. **Process Variables** - Displays the values and Units of Measure of all the Process Variables. The values are continuously updated. In order to display a single Process Variable, select the desired Process Variable and the value of the single Process Variable will be updated at a faster rate than when all Process Variables are displayed.
2. **Diags and Services** - Allows the user to monitor Alarm Status, Background Diagnostic and Sensor Status, to clear latched alarms, and to manually override valve operation.
3. **Basic Setup** - Provides quick access the to most common adjustments including Process Variable Units and re-ranging of the Analog Input and Outputs.
4. **Detailed Setup** - Provides access to all other adjustable device parameters.

## 2-4 Diagnostics and Setup

The Diagnostics and Services menu provides user with a list of functions and services that aid the user in diagnosing problems with the Brooks QUANTIM, the process, and/or the installation.



1. **Alarms & Warnings** - View the status of each alarm type. Possible status values are Normal (No Alarm), Warning, and Alarm.
2. **Reset Alarms** - Resets all latched alarms to Normal. (See the Alarms Section 2-10 for more details).
3. **Diag Results** - View the status of each background diagnostic test. Possible status values are Normal and Failure.
4. **Valve Operations** - Manually override Valve Control and monitor the actual Valve Drive current
5. **Zero Sensor** - Allows the user to remotely zero the sensor. This operation has the same effect as pressing the zero button on the top of the Brooks QUANTIM.
6. **Sensor Status** - Monitor detailed status of the Sensor Circuitry
7. **Sensor Data** - Monitor detailed information related to the Sensor circuitry.

2-5 Basic Setup

The Basic Setup menu provides access to the most common adjustments that a user would normally perform to a Brooks QUANTIM.

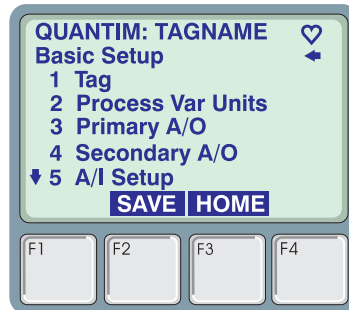

1. **Tag** - Up to 8 Alpha-numeric characters which identify this device. The tagname of the connected device is always displayed on the top line of the HART Communicator. (Refer to the HART Communicator manual for information on entering text from the HART Communicator keypad).
2. **Process Var Units** - Change the Units of Measure for any process variable.
3. **Primary A/O** - Re-range the Primary Analog Output
4. **Secondary A/O** - Re-range the Secondary Analog Output
5. **A/I Setup** - Re-range the Analog Input
6. **Process Damping** - Allows the user to set the damping values for Mass Flow and Density Process Variables.

2-6 Primary and Secondary A/O Menus

The Primary and Secondary Analog Output menus allow the user to re-range the Primary and Secondary Analog Output. The Primary Analog Output is a 4 – 20 mA representation of the Primary Variable, which for Brooks QUANTIM is the Mass Flow Process Variable. Likewise, the Secondary Analog Output is a 4 – 20 mA representation of the Secondary Variable, which for Brooks QUANTIM is the Density Process Variable. The Upper Range Value and the Lower Range Value control the relationship between the Process Variable and the 4 – 20 mA analog output, i.e., the value of the analog output for any given value of the process variable. These menus allow the user to change this relationship.

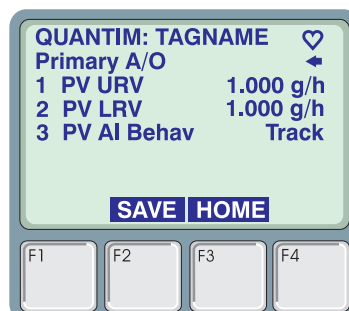

- 1 **PV URV** - The Primary Variable Upper Range Value
- 2 **PV LRV** - The Primary Variable Lower Range Value
- 3 **PV AI Behav** – This defines the behavior of this analog output when an alarm is currently active.

The options are:

**Track** - continue to represent the Primary/Secondary Variable,

**Hold** - hold the value of the Primary/Secondary Variable when the alarm occurred,

**Upscale** - sets the output to 22 mA when an alarm is active,

**Downscale** - sets the output to 3.8 mA when an alarm is active.

### Example - Configuring the Range of the Secondary Analog Output

The user desires to have the Secondary Analog Output represent the Density Process Variable in the following manner:

4 mA when Density = 0.75 g/cc

20 mA when Density = 1.25 g/cc

**Step 1** - From the Home Menu, the user would traverse the menu tree until reaching the Secondary A/O menu as follows:

Home ⇒ Device Setup ⇒ Basic Setup ⇒ Secondary A/O

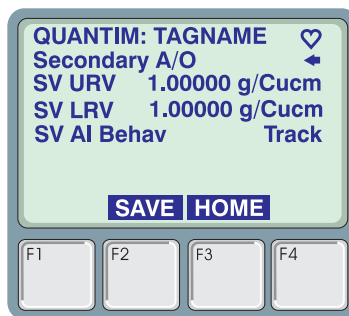

**Step 2** – Select URV or press the “Fast Select Key” 1

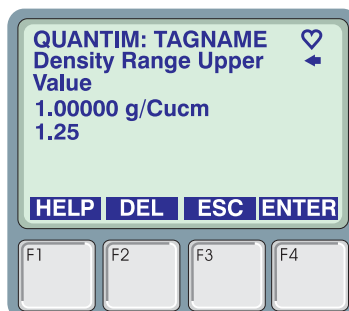

**Step 3** - Enter the desired Upper Range Value, 1.25 and press the ENTER function key. Note that the DEL function key will delete a single digit that you have entered and the ESC function key will exit this screen with out changing the value.

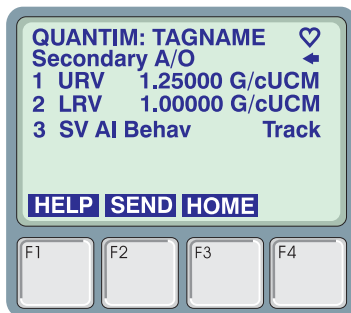

**Step 4** - Select LRV or press the “Fast Select Key” 2

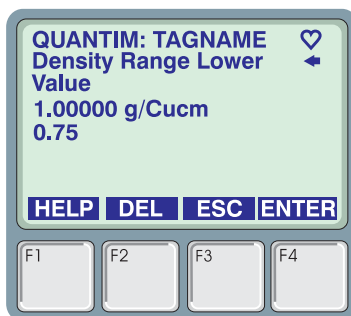

**Step 5** - Enter the desired Lower Range Value, 0.75 and press the ENTER function key (F4)

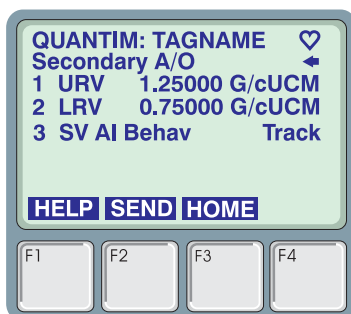

**Step 6** - Note that the modified values have only been changed in the HART Communicator. In order to have the values transferred to the Brooks QUANTIM, do any ONE of the following:

- Press SEND and the values will be sent immediately.
- Press ↵ENTER
- Press HOME

## HART® Operation Manual - QUANTIM®

## 2-7 A/I Setup

The Analog Input Setup menu allows the user to configure the range relationship between the Analog Input and the Setpoint Process Variable.

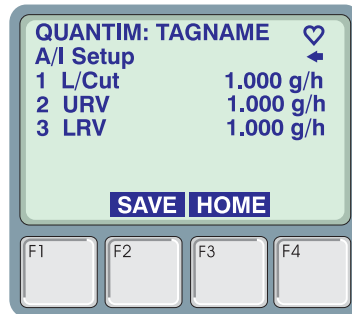

1. **L/Cut** - Low Flow Cutoff allows the user to specify a value of the Setpoint Process Variable below which the Setpoint Process Variable is forced to zero. This can be used to prevent the Brooks QUANTIM from attempting to control flow at very low flowrate in response to noise on the Analog Input.
2. **URV** - The Setpoint Process Variable Upper Range Value
3. **LRV** - The Setpoint Process Variable Lower Range Value

## 2-8 Detailed Setup

The Detailed Setup menu provides access to the all adjustments that a user can perform to a Brooks QUANTIM that have not been covered in other menus.



1. **Analog I/O Config** - allows the user to configure and trim the analog inputs and outputs.
2. **Config Alarms** - allows the user to configure and enable alarms
3. **Device Info** - allows the user to view Device Information such as Model Number, Serial Number, etc.
4. **Polling Address** - allows the user to change the Network Polling Address of the HART Communicator.
5. **Revision Info** - A menu which displays all Revision information about the Device.
6. **Sensor F/W Rev** - Revision of Sensor Firmware.





1. **Universal Rev** - The revision of the HART Protocol Universal Commands Document that the device supports.
2. **Fld Dev Rev** - The revision of the Device Specific HART Protocol Commands Document that the device supports.
3. **Hardware Rev** - The revision of the Hardware of the device.
4. **Firmware Rev** - The revision of the Firmware in the device.

## 2-9 Analog I/O Configuration

The Analog I/O Configure Menu allows the user to configure the physical I/O type and to trim/calibrate the output or input. From this menu the user must select the Input or Output to be configured/trimmed.

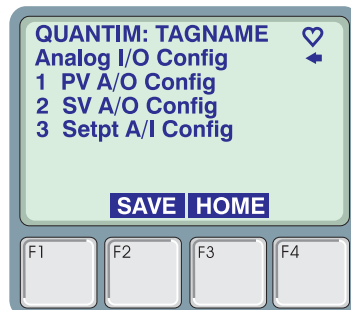

### PV A/O Config

The features of this menu operate only on the Primary Output.

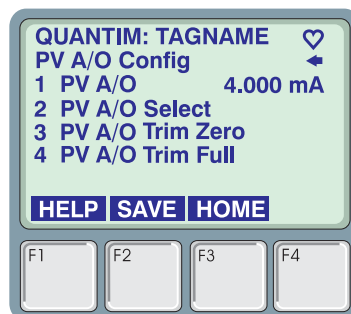

**Example - Trimming the Primary Output**

While the Analog Output is calibrated at the factory for the devices specified accuracy, the user may wish to trim the output values in order to account for long wire runs, equipment variations, etc. This example shows how to perform the Trim operation.

1. **PV A/O** - The actual value on the Primary Output, updated continuously.
2. **PV A/O Trim Zero** - Allows the user to trim the zero or min-scale output. (See example below)
3. **PV A/O Trim Full** - Allows the user to trim the full-scale output. (See example below)

**Step 1** - The user must connect a field calibrator or high accuracy DVM in series with the current loop at the desired location. This meter will be referred to as the “Reference Meter”.

**Step 2** - From the Home Menu, the user would traverse the menu tree until reaching the Primary A/O menu as follows:

Home ⇒ Device Setup ⇒ Detailed Setup ⇒ Analog I/O Config ⇒ Primary A/O

**Step 3** - Select PV A/O Trim Zero or press the Fast Select key 2

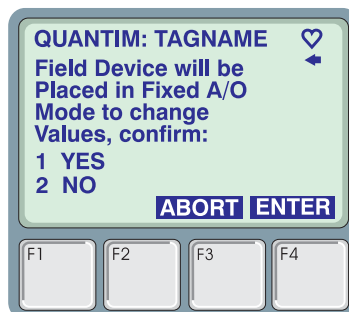

**Step 4** - The user must acknowledge the warning that the analog output is about to be placed in a fixed output mode and will no longer reflect the value of the Primary Variable. Selecting YES confirms that user has taken the necessary precautions so that this action will not interfere with the process that the Brooks QUANTIM is installed in. Selecting NO aborts the Trim operation.

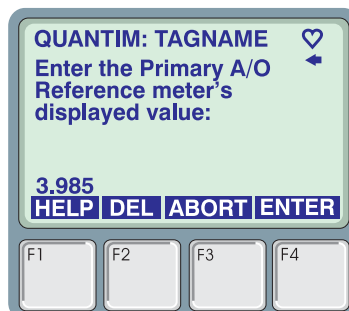

**Step 5** - Enter the value as displayed on the Reference Meter and then press ENTER.

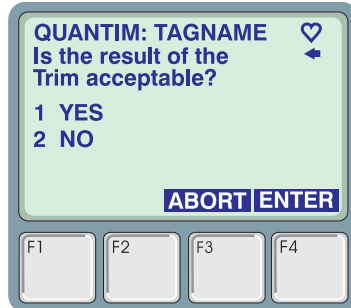

**Step 6** - Read the value displayed on the Reference Meter. If the adjusted value is acceptable, select YES and the Trim operation is complete. If the value is not acceptable, select NO and repeat steps 5 and 6. If the error between the actual value as displayed on the Reference Meter and the ideal value of 4 mA is too large, it may require several passes of repeated steps 5 and 6 before an acceptable value is achieved.

**Step 7** - Repeat Steps 3 – 6 for the Full Scale output.

**SV A/O Config**

The features of this menu operate only on the Secondary Output.

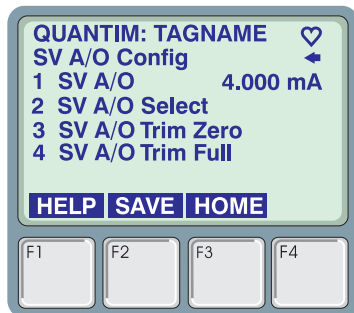

1. **SV A/O** - The actual value on the Secondary Output, updated continuously.
2. **SV A/O Trim Zero** - Allows the user to trim the zero or min-scale output. (See example for Primary Output)
3. **SV A/O Trim Full** - Allows the user to trim the full-scale output. (See Section 2-6 for example Primary Output)

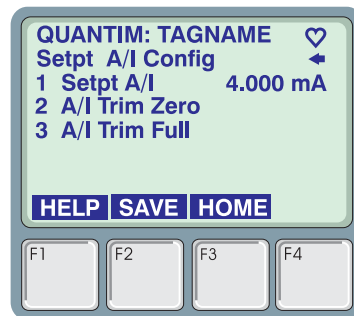
**Setpt A/I Configuration**

1. **Stpt A/I** - The actual value measured on the analog input
2. **A/I Trim Zero** - Allows the user to trim the zero or min-scale input. (See example below)
3. **A/I Trim Full** - Allows the user to trim the full-scale input. (See example below)

**Example - Trimming the Analog Input**

**Note:** To perform this operation, the user must have a current source connected to the analog input which can be manipulated to min-scale and full-scale values.

**Step 1** - Connect a current source to the analog input and set the input to the desired min-scale value, normally 4.000 mA.

**Step 2** - From the Home Menu, the user would traverse the menu tree until reaching the Setpt A/I Config menu as follows:

Home ⇒ Device Setup ⇒ Detailed Setup ⇒ Analog I/O Config ⇒ Setpt A/I Config

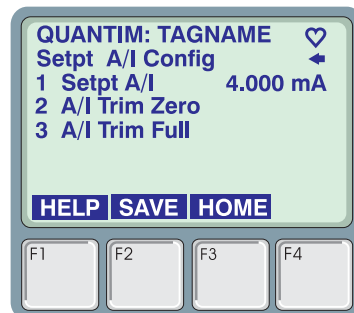

**Step 3** – Select A/I Trim Zero or press Fast Select Key 2

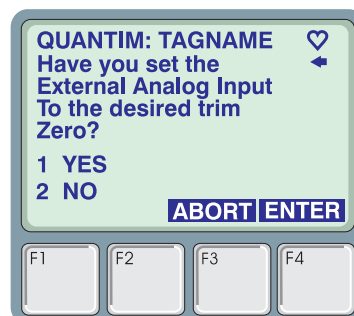

**Step 4** - Select YES to confirm that the current source is connected and set to the desired min-scale value. Selecting NO will terminate the Trim operation.

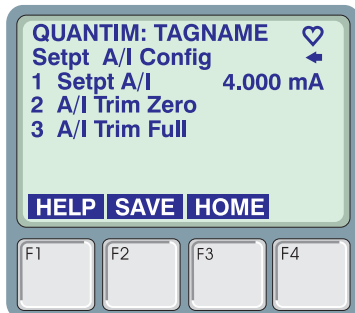

**Step 5** - Change the current source to provide the desired full-scale value, normally 20 mA. Then select A/I Trim Full or press Fast Select key 3.

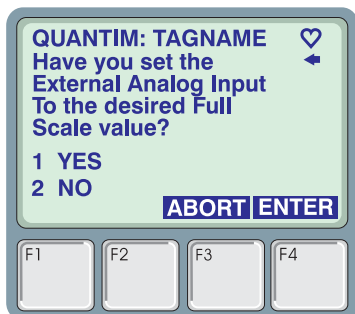

**Step 6** - Select YES to confirm that the current source is connected and set to the desired full-scale value. Selecting NO will terminate the Trim operation.

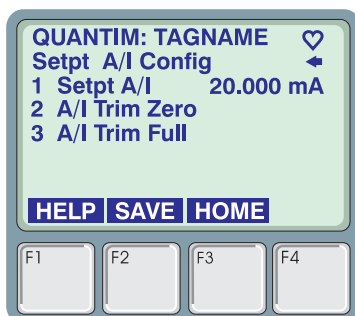

The Trim operation is complete.

## 2-10 Alarms

Brooks' QUANTIM provides the user a flexible alarm/warning system that monitors Process Variables for conditions that fall outside configurable limits and then provides feedback to the user visually via the alarm LED, via an alarm contact, and via HART.

There are two types of Alarms/Warnings: Those that monitor a Process Variable and compare the value to specified limits and those that monitor a state of the device such as a Diagnostic Failure. The available alarms/warnings are:

- MassFlow
- Density
- Volumetric Flow
- Temperature
- Slug Flow
- Diagnostic Failure

The alarm/warning named Slug Flow monitors the Density Process Variable, but allows the user to specify conditions for the alarm that may be different from the Density alarm. Typically, the Density alarm would be used to detect small changes in the density of the fluid passing through a Brooks QUANTIM, while, as the name implies, the Slug Flow alarm would be used to detect a slug of a different fluid with much different density characteristics (such as air when measuring a liquid).

Each alarm has several attributes which may be configured by the user. These attributes control the conditions which cause the alarm/warning to occur and also specify actions to be taken when the Process Variable is outside the specified conditions.

These attributes are:

1. **Severity** - The options are 0 = Off, 1 = Warning, 2 = Alarm. When set to Off, the conditions are not monitored and no actions will be taken. When set to Warning, the Alarm LED will flash Green when the monitored value exceeds the specified conditions. (See Alarm Code attribute). When set to Alarm, the Alarm LED will flash Red and the Analog Outputs will act based on the assigned Alarm Behavior (See Basic Setup, Primary and Secondary A/O Menus) when the monitored value exceeds the specified conditions.
2. **Alarm Code** - The alarm code specifies the code to be flashed on the LED to indicate that an alarm/warning condition has occurred. When more than one alarm/warning is active, then the LED will indicate the most severe alarm with the highest Alarm Code. An Alarm is more severe than a Warning. Alarm Codes do not have to be unique, i.e., more than one alarm/warning type can use the same alarm code.

3. **Latching Enable** - When set to 0, the alarm/warning is non-latching. That means the alarm is indicated only when the monitored value exceeds the specified conditions. When set to 1, the alarm/warning is Latching. This means that the alarm/warning will be indicated when the monitored value first exceeds the specified conditions, and will be indicated until the user clears the alarm. If the user clears the alarm while the monitored value still exceeds the specified conditions, then the alarm will be re-latched and continue to be indicated. The user must clear the alarm/warning via the Diags and Services menu, Reset Alarms selection.
4. **Contact Enable** - QUANTIM has an Alarm contact (0 to 5 V) on pin 3. 5V indicates no alarm, 0 V indicates alarm. If the alarm condition is detected and the severity is alarm or warning, and the alarm contact is enabled, then the alarm contact is “closed” (0 V).
5. **Low Limit** - The value of the monitored value below which is considered an alarm/warning condition. (This attribute not valid for alarms that monitor a state condition of the device.)
6. **High Limit** - The value of the monitored value above which is considered an alarm/warning condition. (This attribute not valid for alarms that monitor a state condition of the device.)
7. **Delay** - The time in seconds that the value must remain above the high limit or below the low limit before an alarm/warning condition is indicated.

## 2-11 Configuring Alarms

The user can enable and configure all alarms/warnings via the menu:

Device Setup ⇒ Detailed Setup ⇒ Config Alarms



1. **Select Alarm** - allows the user to select the alarm to be configured. The currently selected alarm is displayed.
2. **Configure Alarm** - allows the user to configure the 7 attributes of the selected alarm.



The user selects an alarm by scrolling up/down the list of available alarms until the desired alarm is highlighted and then presses ENTER.

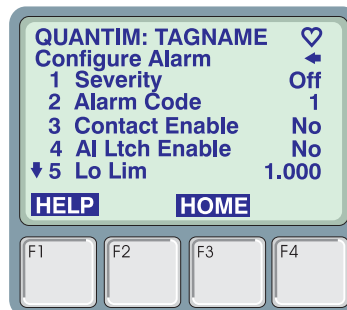

1. **Severity** - Enables the alarm and set the severity. Options are Off, Warning, Alarm.
2. **Alarm Code** - Specifies the Code to be flashed on the Alarm Led. When multiple alarms are active, the alarm with the highest alarm code is displayed.
3. **Contact Enable** - Enables the alarm contact for this alarm. Options are No and Yes.
4. **Al Ltch Enable** - When set to Yes the alarm will latch when detected and must be cleared via the Diags and Services menu.
5. **Lo Lim** - The value of the monitored Process Variable below which the alarm will activated.
6. **Hi Lim** - The value of the monitored Process Variable above which the alarm will activated.
7. **Delay** - The time in seconds that the Process Variable must be outside the limits specified by Lo Lim and Hi Lim before the alarm will be activated.



## 2-12 Device Information

The Device Info menu provides access to informational parameters of the device. None of the items in this menu affect the operation of this device and most of the items in this menu cannot be modified.

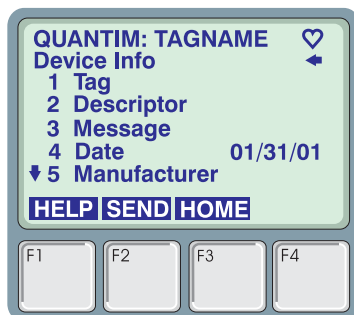

1. **Tag** - Up to 8 Alpha-numeric characters which identify this device. The tagname of the connected device is always displayed on the top line of the HART Communicator. (Refer to the HART Communicator manual for information on entering text from the HART Communicator keypad).
2. **Descriptor** - Up to 16 Alpha-numeric characters which can be used to further identify this device.
3. **Message** - Up to 32 Alpha-numeric characters which can be used for service information or any other user specific purpose.
4. **Date** - A date field that the user can modify that can be used for calibration date, service date, etc.
5. **Manufacturer** - View only field which identifies the manufacturer of this device.
6. **Dev ID** - View only Unique Device ID that is assigned by the manufacturer.
7. **Model #** - Model Number of the device and is set by the manufacturer.
8. **Serial #** - Serial Number of the device and is set by the manufacturer.
9. **PV Snsr S/N** - Serial Number of the Sensor sub-assembly.

## HART® Operation Manual - QUANTIM®

## 2-13 Hot Keys

The Hot Key menu provides quick access to frequently used menus. The Hot Key menu is accessed by pressing the >>> button. The menus that are available via the Hot Key are shown in diagram below. User-definable Hot Key menus are not supported.



Table 2-1 Supported HART Protocol Commands

Cmd #	Cmd Type			Command Description
	U 1	C 2	D 3	
0	●			Read Unique Identifier
1	●			Read Primary Variable
2	●			Read PV Current and Percent of Rate
3	●			Read Dynamic Variables and PV Current
6	●			Write Polling Address
11	●			Read Unique Identifier with Associated Tag
12	●			Read Message
13	●			Read Tag, Descriptor, Date
14	●			Read Primary Variable Sensor Information
15	●			Read Primary Variable Output Information
16	●			Read Final Assembly Number
17	●			Write Message
18	●			Write Tag, Descriptor, Date
19	●			Write Final Assembly Number
33		●		Read Transmitter Variables
35		●		Write Primary Variable Range Values
38		●		Reset Configuration Changed Flag
44		●		Write Primary Variable Units
48		●		Read Additional Transmitter Status
53		●		Write Transmitter Variable Units
54		●		Read Transmitter Variable Information
55		●		Write Transmitter Variable Damping Value
59		●		Write Number of Response Preambles
60		●		Read Analog Output and Percent of Range
66		●		Enter/Exit Fixed Analog Output Mode
67		●		Trim Analog Output Zero
68		●		Trim Analog Output Gain
110		●		Read All Dynamic Variables
128			●	Perform User Zero
131			●	Read Software Rev
132			●	Read Model Number

Table 2-1 Supported HART Protocol Commands (Continued)

Cmd #	Cmd Type			Command Description
	U 1	C 2	D 3	
134			●	Read Serial Number
136			●	Read Alarm Configuration
137			●	Write Alarm Configuration
138			●	Clear Alarms
140			●	Write Secondary Variable Units
141			●	Write Secondary Variable Range Units
142			●	Read Secondary Variable
143			●	Read Secondary Variable Current and Percent of Range
144			●	Read Secondary Variable Output Information
155			●	Read Transmitter Variable Damping Value
160			●	Trim Analog Input Zero
161			●	Trim Analog Input Gain
165			●	Read Output Configuration
166			●	Write Output Configuration
170			●	Read Primary Output Analog Output Alarm Behavior
171			●	Write Primary Output Analog Output Alarm Behavior
172			●	Read Secondary Output Analog Output Alarm Behavior
173			●	Write Secondary Output Analog Output Alarm Behavior
200			●	Read Setpoint Low Flow Cutoff
201			●	Write Setpoint Low Flow Cutoff
202			●	Read Setpoint Current and Percent of Range
203			●	Write Setpoint Range Values
204			●	Read Setpoint Range Values
205			●	Read Valve Override State and Valve Drive Value
206			●	Write Valve Override State
207			●	Write Setpoint and Setpoint Source
210			●	Read Sensor Processor Information

Command Types 1 – Universal Command Set , 2 – Common Practice Command Set, 3 – Device Specific Commands

HART® Operation Manual - QUANTIM®

Figure 2-4 Home Menu Tree

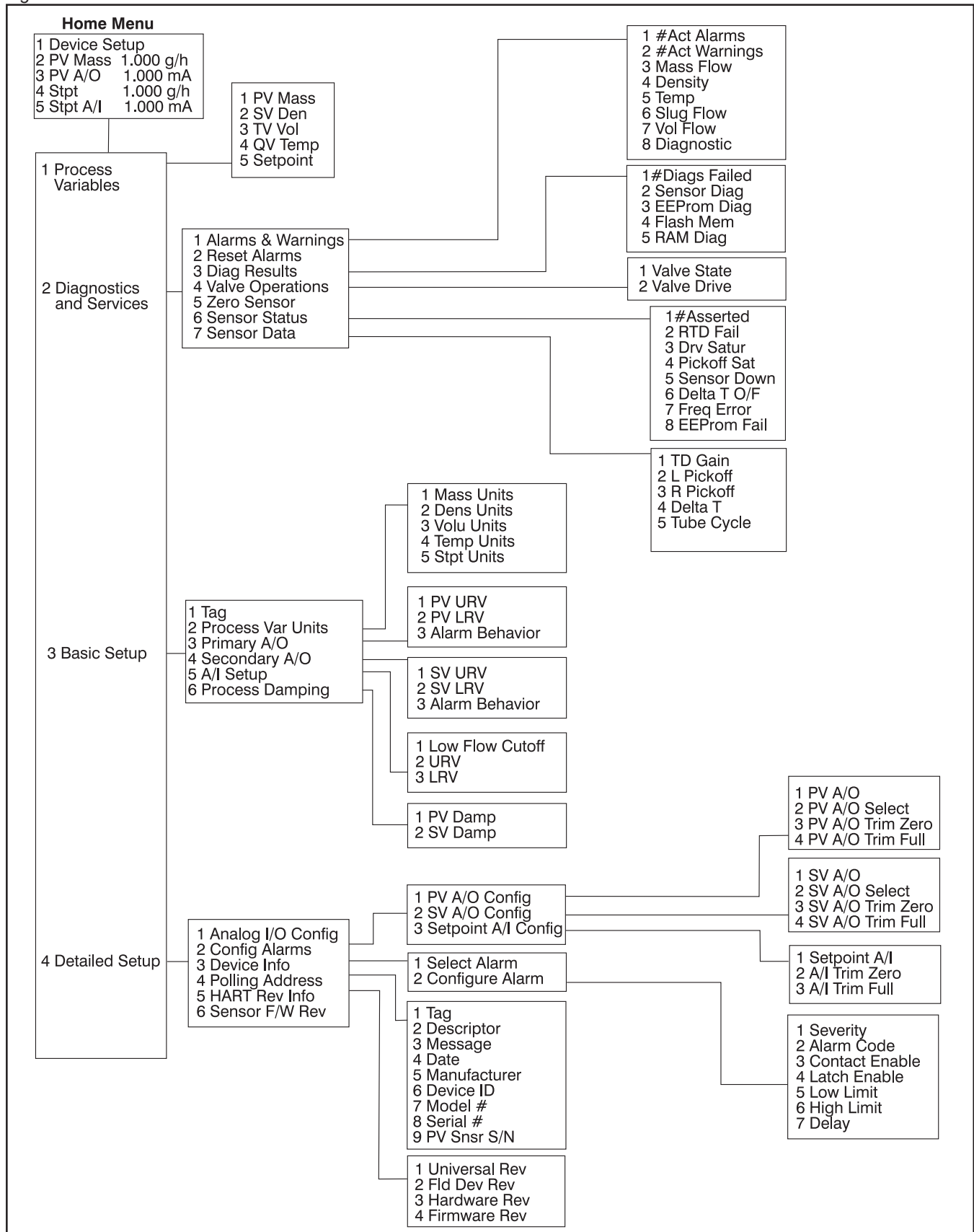

*THIS PAGE WAS  
INTENTIONALLY  
LEFT BLANK*

**HART® Operation Manual - QUANTIM®**

---

**LIMITED WARRANTY**

Visit [www.BrooksInstrument.com](http://www.BrooksInstrument.com) for the terms and conditions of our limited warranty.

**BROOKS SERVICE AND SUPPORT**

Brooks is committed to assuring all of our customers receive the ideal flow solution for their application, along with outstanding service and support to back it up. We operate first class repair facilities located around the world to provide rapid response and support. Each location utilizes primary standard calibration equipment to ensure accuracy and reliability for repairs and recalibration and is certified by our local Weights and Measures Authorities and traceable to the relevant International Standards.

*Visit [www.BrooksInstrument.com](http://www.BrooksInstrument.com) to locate the service location nearest to you.*

**START-UP SERVICE AND IN-SITU CALIBRATION**

Brooks Instrument can provide start-up service prior to operation when required.

For some process applications, where ISO-9001 Quality Certification is important, it is mandatory to verify and/or (re)calibrate the products periodically. In many cases this service can be provided under in-situ conditions, and the results will be traceable to the relevant international quality standards.

**SEMINARS AND TRAINING**

Brooks Instrument can provide seminars and dedicated training to engineers, end users and maintenance persons.

*Please contact your nearest sales representative for more details.*

Due to Brooks Instrument's commitment to continuous improvement of our products, all specifications are subject to change without notice.

**TRADEMARKS**

Brooks and Quantim are trademarks of Brooks Instrument, LLC  
All other trademarks are the property of their respective owners.

**Global Headquarters**

**Brooks Instrument**  
407 West Vine Street  
Hatfield, PA  
19440-0903 USA

Toll-Free (USA): 888-554-FLOW  
T: 215-362-3500  
F: 215-362-3745

[BrooksAM@BrooksInstrument.com](mailto:BrooksAM@BrooksInstrument.com)

A list of all Brooks Instrument locations and contact details can be found at [www.BrooksInstrument.com](http://www.BrooksInstrument.com)

---